



Equipment for the Foodservice Industry

value + quality + service

Bottom Mount Reach-in Freezer

F1-27VC-L



F1-27VC-L

Features

Features:

- Bottom-mounted cooling unit is easy to remove and clean
- Environmentally friendly R290 refrigerant
- Exterior & interior stainless steel construction
- Dixell digital temperature control system
- Heavy duty Embraco compressor
- Self-closing and stay open door
- Auto evaporation of defrosting water
- Recessed door handles
- Safe lock for safe and secure use
- Removable gasket that is easy to clean and replace
- Adjustable/removable plastic coated wire shelves
- Shelves can be set-up to hold standard full size hotel pans
- Casters for easy movement

Warranty:

- Two year parts and labour; Five years on compressor.
For full warranty details visit <https://www.efifoodequip.com/warranty-info.php>



F1-27VC-L

Specifications

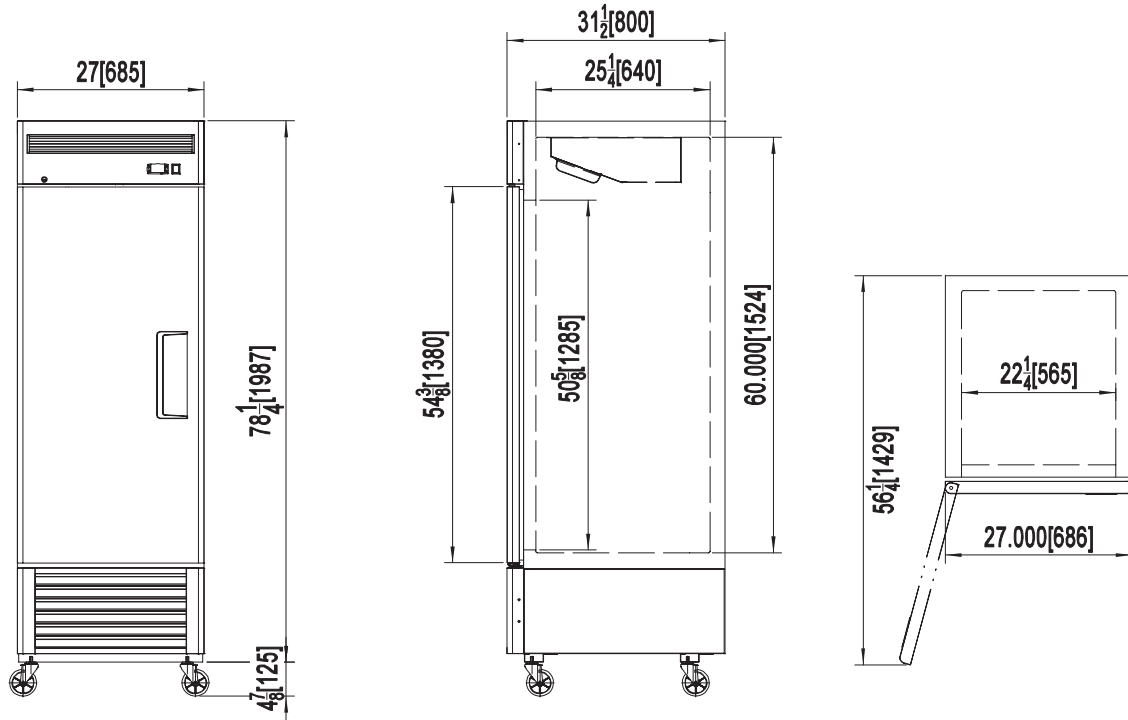

Model	Refrigerant	Doors	Shelves	Dimension (mm) (inch)			HP	Voltage	Amps	Capacity (L) (Cu Ft.)	Net Weight (KG) (LBS)	Temperature Range
				L	D	H						
F1-27VC-L	R290	1	3	685	800	2135	1/2	115/60	6.3	541	120	-8 ~ -1°F
				27.0	31.5	84.1						

Equipped with one NEMA 5-15P plug 

Shipping Information

Crate Dimensions (mm) (inch)			Net Weight (KG) (LBS)	Gross Weight (KG) (LBS)
L	D	H		
739	862	2154	120	135
29.1	33.9	84.8	265	298

Specifications subject to change without notice.